

# In the classroom



Name: \_\_\_\_\_

Match the words and the pictures.



pencil



blackboard

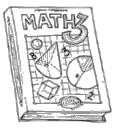

schoolbag

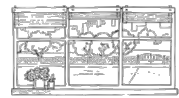

pencil case



window

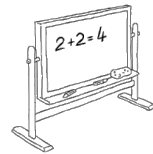

chalk

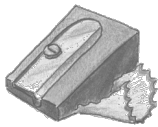

door

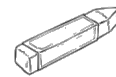

desk and chair

book



exercise book/  
notebook



teacher



pencil sharpener

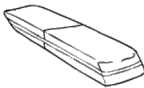

rubber/ eraser



# In the classroom



Lösung

Match the words and the pictures.

pencil

blackboard

schoolbag

pencil case

window

chalk

door

desk and chair

book

exercise book/  
notebook

teacher

pencil sharpener

rubber/ eraser

# In the classroom



Name: \_\_\_\_\_

one two three four five six seven eight nine ten eleven twelve  
thirteen



\_\_\_\_\_ pencils

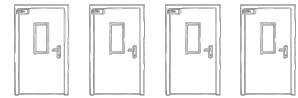

\_\_\_\_\_ blackboards

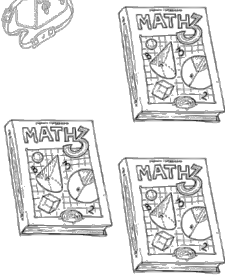

\_\_\_\_\_ schoolbags

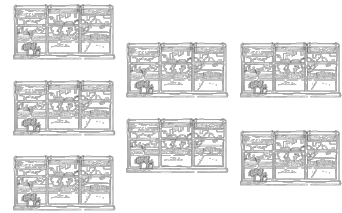

\_\_\_\_\_ pencil cases

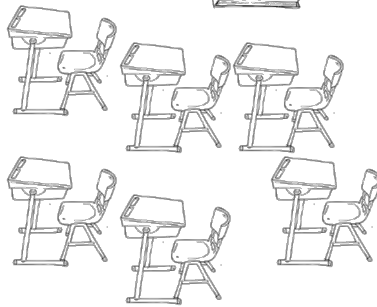

\_\_\_\_\_ windows

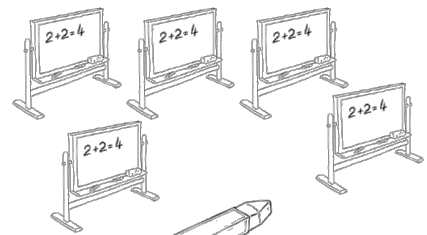

\_\_\_\_\_ chalks

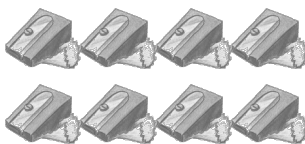

\_\_\_\_\_ doors

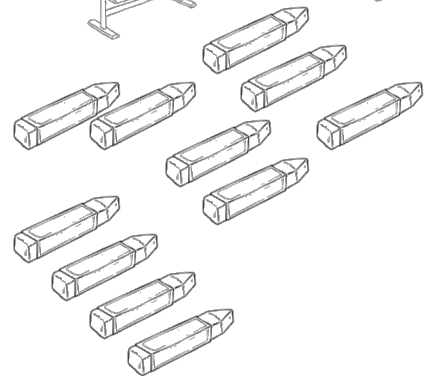

\_\_\_\_\_ desks and

\_\_\_\_\_ chairs



\_\_\_\_\_ books

\_\_\_\_\_ exercise books/  
notebooks

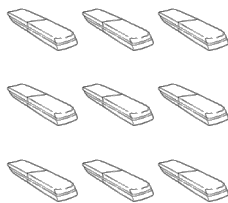

\_\_\_\_\_ teacher

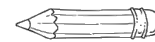

\_\_\_\_\_ pencil sharpeners

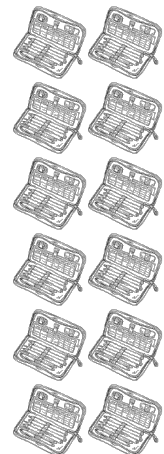

\_\_\_\_\_ rubbers/ erasers



# In the classroom



# Lösung

one two three four five six seven eight nine ten eleven twelve thirteen



two pencils



five blackboards



ten schoolbags

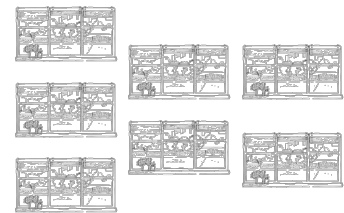

twelve pencil cases

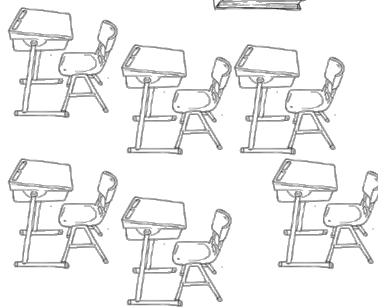

seven windows

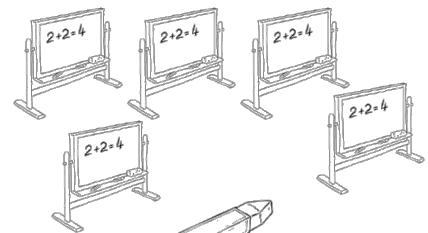

eleven chalks

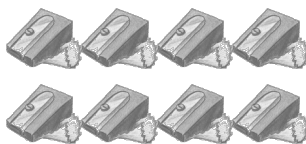

four doors

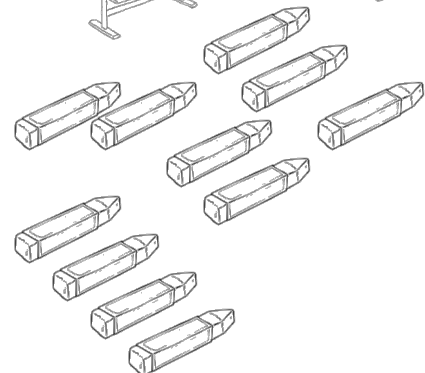

six desks and six chairs



three books

thirteen exercise books/  
notebooks



one teacher

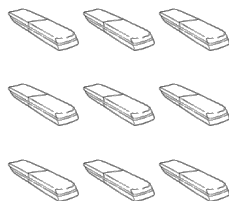

eight pencil sharpeners

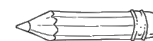

nine rubbers/ erasers

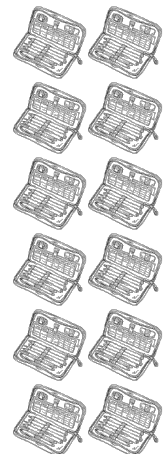

# In the classroom



Name: \_\_\_\_\_

one two three four five  
six seven eight nine ten  
eleven twelve thirteen

blackboards schoolbags doors books pencils rubbers/erasers  
teacher desks and chairs windows pencil sharpeners pencil cases  
chalks

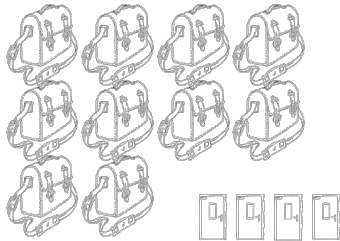

I see ten schoolbags.

I see

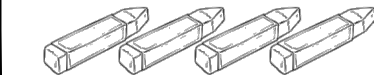
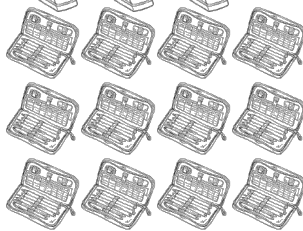
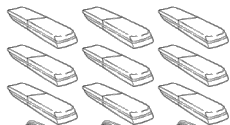
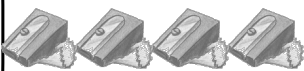
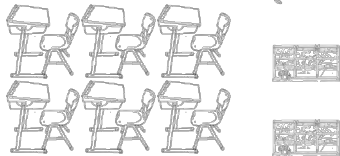

# In the classroom



# Lösung

one two three four five  
six seven eight nine ten  
eleven twelve thirteen

blackboards schoolbags doors books pencils rubbers/erasers  
teacher desks and chairs windows pencil sharpeners pencil cases  
chalks

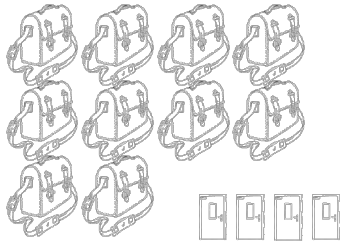

I see ten schoolbags.

I see four doors.



I see three books.

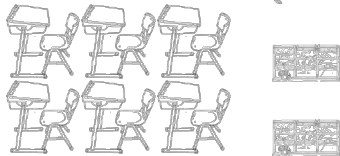

I see one teacher.

I see six desks and chairs.



I see five blackboards.

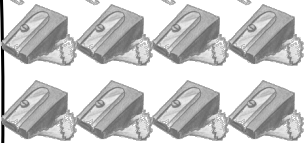

I see eight pencil sharpeners.



I see two pencils.

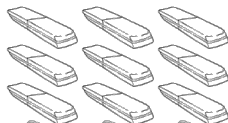

I see nine rubbers.

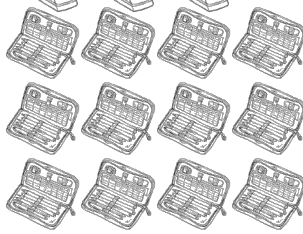

I see twelve pencil cases.

I see eleven chalks.

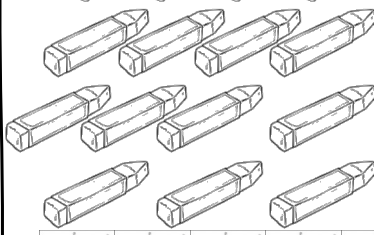

I see thirteen exercise books.

I see seven windows.



# In the classroom

Name: \_\_\_\_\_

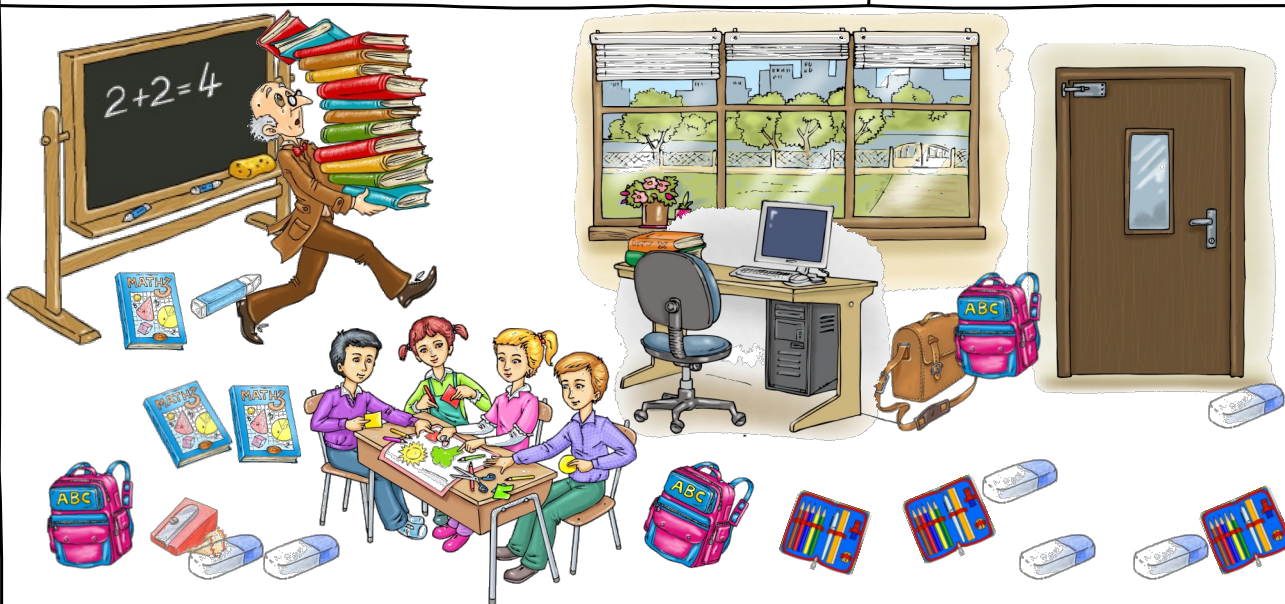

desk • thirteen • window • blackboard • fifteen • rulers • brown • teacher • schoolbag • books • Three • rubbers

The \_\_\_\_\_ is carrying \_\_\_\_\_ books.

Three math \_\_\_\_\_ are on the floor.

Four children are sitting at a \_\_\_\_\_.

In the pencil cases you can see \_\_\_\_\_ pencils and three \_\_\_\_\_.

Six white and blue \_\_\_\_\_ are on the floor.

\_\_\_\_\_ girls have the same \_\_\_\_\_. It is pink, blue and yellow.

One chalk is under the \_\_\_\_\_.

The \_\_\_\_\_ door is closed. There is a \_\_\_\_\_ in the middle.

# In the classroom ☆☆☆☆

# Lösung



desk • thirteen • window • blackboard • fifteen • rulers • brown • teacher • schoolbag • books • Three • rubbers

The teacher is carrying thirteen books.

Three math books are on the floor.

Four children are sitting at a desk .

In the pencil cases you can see fifteen pencils and three rulers .

Six white and blue rubbers are on the floor.

Three girls have the same schoolbag . It is pink, blue and yellow.

One chalk is under the blackboard.

The brown door is closed. There is a window in the middle.